

## ANALYSIS OF ORTHOTROPICALLY MODELED STIFFENED PLATES

A. DEB

212 Ketter Hall, State University of New York, Buffalo, NY 14260, U.S.A.

M. K. DEB

E.M.R.C., Troy, MI 48084, U.S.A.

and

M. BOOTON

Faculty of Engineering and Applied Science, Memorial University of Newfoundland,  
St John's, Canada A1B 3X5

(Received 24 November 1989; in revised form 19 April 1990)

**Abstract**—In the past, formulations for technically orthotropic plates appear to have been based only on Kirchhoff's assumptions for the classical thin plate theory. In the present paper, the authors have studied a formulation applicable to eccentrically stiffened plates based on the Reissner-Mindlin plate theory. Due to the formidability of the 10th-order governing equations of this formulation in yielding closed form analytical solutions, recourse has been taken to the finite element method. The range of validity of the orthotropic model, so dependent upon the proximity of stiffeners, has been assessed and demarcated by comparison with a more general discrete plate-beam model using the techniques of dimensional analysis. Finally, results are presented for the geometrically non-linear orthotropic plate and comparisons are made with the work of earlier investigators to highlight the fact that the degree of eccentricity of stiffeners is an important factor to be taken into account, in addition to the volumetric ratio between plate and stiffeners.

### INTRODUCTION

The problem of the bending of eccentrically stiffened plates does not lend itself to easy analytical solutions even for simple geometries and boundary conditions. Consequently, idealization of a stiffened plate, which can be treated as an integral system of plate and beams, by means of another plate of same thickness as the parent plate but possessing equivalent, directionally varying properties, has been quite popular (Bares and Massonnet, 1966; Troitsky, 1971). In the literature, such idealized plates with the stiffeners smeared out are termed as "technically orthotropic plates" on account of their resemblance with plates of truly orthotropic materials. In the past, to the authors' knowledge, orthotropic plate theories relevant to eccentrically stiffened plates have been based on Kirchhoff's assumptions of the classical thin plate theory, as well as the Euler-Bernoulli beam theory. In the present work, a higher order orthotropic plate theory for eccentric stiffeners, based on the Reissner-Mindlin plate theory and Timoshenko beam theory is considered. The governing equations for the present idealization are of the 10th-order and appear to be quite intractable in terms of obtaining closed form solutions, even for simple geometries and boundary conditions. The most convenient tool yielding approximate solutions acceptable for engineering purposes, seems to be an energy method like the finite element method. This widely applied numerical technique has been used here with the eight-noded, quadratic plate bending element (Mukhopadhyay and Satsangi, 1984; Deb and Booton, 1988) employing reduced integration. A common premise of the orthotropic plate theories in the context of orthogonally stiffened plates is the assumption of closeness of torsionally-soft stiffeners. As a result, these theories may give rise to significantly erroneous results unless the stiffeners are "reasonably" closely spaced. In order to be able to apply a smeared plate or an orthotropic plate theory with confidence, it is therefore essential on the part of an analyst to know, quantitatively, the extent of its validity in terms of the approximations involved. In this study, the same has been accomplished by comparing the results from the finite element

formulation based on the higher order orthotropic theory (ORTHO), with the corresponding general discrete plate-beam finite element model [FEM(M2)]. The effectiveness of the latter formulation has already been studied (Mukhopadhyay and Satsangi, 1984; Deb and Booton, 1988). In the numerical comparison between the models ORTHO and FEM(M2), concepts of dimensional analysis have been applied. The authors have not come across any literature that gives any quantitative information on the degree of approximation incorporated by the smearing of stiffeners in an orthotropic theory. Having demarcated the extent of validity of the present orthotropic model considering small-deformation linear elastic behavior, a comparison has been made for geometrically non-linear behavior with the results given by Srinivasan and Ramchandran (1977). The main aim in this comparison has been to point out that the degree of eccentricity of stiffeners is an important factor in affecting the behavior of a stiffened plate, for a given volumetric ratio of plates to stiffeners. It may be recognized that despite the availability of a general formulation like the FEM(M2), the formulation ORTHO may be extremely advantageous in terms of simplicity of input data and computational efficiency in such cases where a fine grid of stiffeners is present.

### CONSTITUTIVE MODEL AND GOVERNING EQUATIONS

The principal assumptions in the present formulation are the following:

- (i) Transverse shear deformation is accounted for in the same manner as in the Reissner-Mindlin plate theory and Timoshenko beam theory.
- (ii) Normal stress in a direction perpendicular to the plane of the plate is neglected.
- (iii) A typical stiffener section is assumed to be symmetric about a vertical plane bisecting the web.
- (iv) The in-plane bending of stiffeners is neglected.
- (v) Stiffeners are assumed orthogonal and equally and closely spaced.
- (vi) Stiffeners in any one direction are all of identical cross-section.
- (vii) Stiffeners are of open web and slender type, possessing negligible torsional stiffness.

In terms of the relevant translational ( $u$ ,  $v$  and  $w$ ) and rotatory ( $\theta_x$  and  $\theta_y$ ) degrees of freedom of the plate mid-surface ( $z = 0$ ), the following displacement field is assumed for the stiffened plate continuum (the positive signs of  $\theta_x$  and  $\theta_y$  tally with the assumption that sagging bending moments are positive):

$$\begin{Bmatrix} U \\ V \\ W \end{Bmatrix} = \begin{Bmatrix} u - z\theta_x \\ v - z\theta_y \\ w \end{Bmatrix}. \quad (1)$$

The relevant engineering strains for infinitesimal deformations are then given as follows:

$$\begin{Bmatrix} \epsilon_x \\ \epsilon_y \\ \gamma_{xy} \\ \gamma_{xz} \\ \gamma_{yz} \end{Bmatrix} = \begin{Bmatrix} U_{,x} \\ V_{,y} \\ U_{,y} + V_{,x} \\ U_{,z} + W_{,x} \\ V_{,z} + W_{,y} \end{Bmatrix}. \quad (2)$$

Therefore, for an isotropic material, the stresses in the plate are:

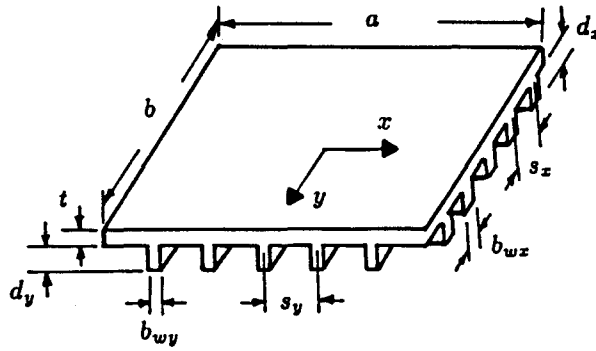

Fig. 1. Geometry of an orthotropic plate.

$$\begin{Bmatrix} \sigma_{px} \\ \sigma_{py} \\ \tau_{pxy} \\ \tau_{pvz} \\ \tau_{pvz} \end{Bmatrix} = \begin{bmatrix} c_{11} & c_{12} & 0 & 0 & 0 \\ c_{12} & c_{22} & 0 & 0 & 0 \\ 0 & 0 & c_{44} & 0 & 0 \\ 0 & 0 & 0 & c_{55} & 0 \\ 0 & 0 & 0 & 0 & c_{66} \end{bmatrix} \begin{Bmatrix} \epsilon_x \\ \epsilon_y \\ \gamma_{xy} \\ \gamma_{xz} \\ \gamma_{yz} \end{Bmatrix} \quad (3)$$

where, in terms of Young's modulus  $E_p$ , Poisson's ratio  $\mu$ , shear modulus  $G_p$  and a shear correction factor  $k_1$  (usually taken as  $\frac{5}{6}$ ),

$$c_{11} = \frac{E_p}{1 - \mu^2} = c_{22} \quad (3.1)$$

$$c_{12} = \frac{\mu E_p}{1 - \mu^2} \quad (3.2)$$

$$c_{44} = G_p \quad (3.3)$$

$$c_{55} = c_{66} = k_1 G_p. \quad (3.4)$$

Relevant stresses in the  $x$ -stiffeners are:

$$\begin{Bmatrix} \sigma_{xx} \\ \tau_{xz} \end{Bmatrix} = \begin{bmatrix} E_{xx} & 0 \\ 0 & k_2 G_{xx} \end{bmatrix} \begin{Bmatrix} \epsilon_x \\ \gamma_{xz} \end{Bmatrix} \quad (4)$$

Relevant stresses in the  $y$ -stiffeners are:

$$\begin{Bmatrix} \sigma_{yy} \\ \tau_{yz} \end{Bmatrix} = \begin{bmatrix} E_{yy} & 0 \\ 0 & k_2 G_{yy} \end{bmatrix} \begin{Bmatrix} \epsilon_y \\ \gamma_{yz} \end{Bmatrix} \quad (5)$$

In (4) and (5),  $E_{xx}$ ,  $E_{yy}$  and  $G_{xx}$ ,  $G_{yy}$  are pairs of Young's and shear moduli, respectively, for  $x$ - and  $y$ -stiffeners, and,  $k_2$  is a shear correction factor usually taken as  $\frac{2}{3}$  for rectangular cross-sections.

By virtue of the assumptions outlined previously, the generalized stresses (stress-resultants) can be obtained by smearing out the stiffeners over the plate spans and integrating the relevant quantities over the plate thickness and the stiffener depths. Typically, the bending moment  $M_x$  can be obtained as shown below for the special case of rectangular stiffeners (see Fig. 1) by summing contributions due to plates and stiffeners:

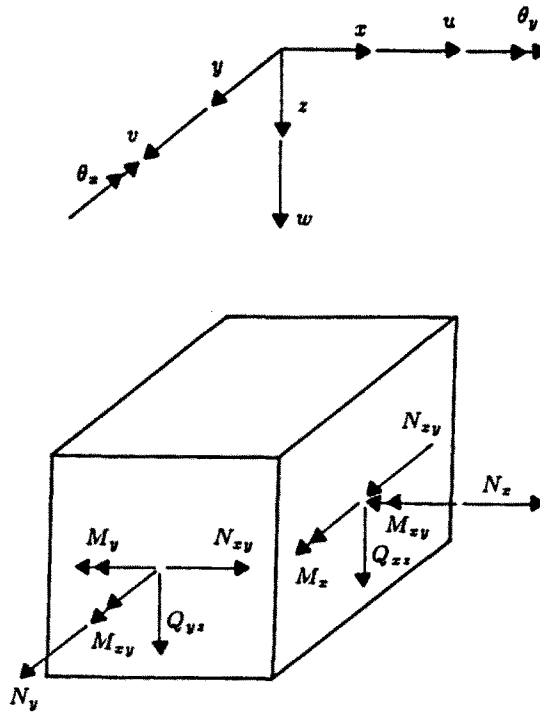

Fig. 2. Positive generalized displacements and stresses.

$$\begin{aligned}
 M_x &= \int_{-t/2}^{t/2} z \sigma_{px} dz + \frac{n_{xx} b_{wx}}{b} \int_{t_2}^{t/2+d} z \sigma_{xx} dz \\
 &= \frac{1}{2} r_v E_v d_v (t+d_v) u_{,x} - \left\{ \frac{E_p t^3}{12(1-\mu^2)} + \frac{1}{2} r_v E_v d_v (d_v^2 + \frac{1}{2} d_v t + \frac{1}{4} t^2) \right\} \theta_{,xx} \\
 &\quad - \frac{\mu E_p t^3}{12(1-\mu^2)} \theta_{,xy}. \quad (6)
 \end{aligned}$$

The remaining stress-resultants (with the sign conventions in Fig. 2) can be obtained similarly leading to a constitutive relation of the following type for the "technically orthotropic" plate (where the stiffness elements are defined in the Appendix):

$$\begin{Bmatrix} N_x \\ N_y \\ N_{xy} \\ M_x \\ M_y \\ M_{xy} \\ Q_{xz} \\ Q_{yz} \end{Bmatrix} = \begin{bmatrix} C_{11} & C_{12} & 0 & C_{14} & 0 & 0 & 0 & 0 \\ C_{12} & C_{22} & 0 & 0 & C_{25} & 0 & 0 & 0 \\ 0 & 0 & C_{33} & 0 & 0 & 0 & 0 & 0 \\ C_{14} & 0 & 0 & C_{44} & C_{45} & 0 & 0 & 0 \\ 0 & C_{25} & 0 & C_{45} & C_{55} & 0 & 0 & 0 \\ 0 & 0 & 0 & 0 & 0 & C_{66} & 0 & 0 \\ 0 & 0 & 0 & 0 & 0 & 0 & C_{77} & 0 \\ 0 & 0 & 0 & 0 & 0 & 0 & 0 & C_{88} \end{bmatrix} \begin{Bmatrix} u_x \\ v_y \\ u_{,y} + v_{,x} \\ -\theta_{,xx} \\ -\theta_{,yy} \\ -(\theta_{,xy} + \theta_{,yx}) \\ w_{,x} - \theta_x \\ w_{,y} - \theta_y \end{Bmatrix}. \quad (7)$$

In symbolic notation, let (7) be written as,

$$\bar{\sigma} = C \bar{\epsilon}_L. \quad (7.1)$$

If an unstiffened plate is made of a specially orthotropic material, i.e. the one for which the

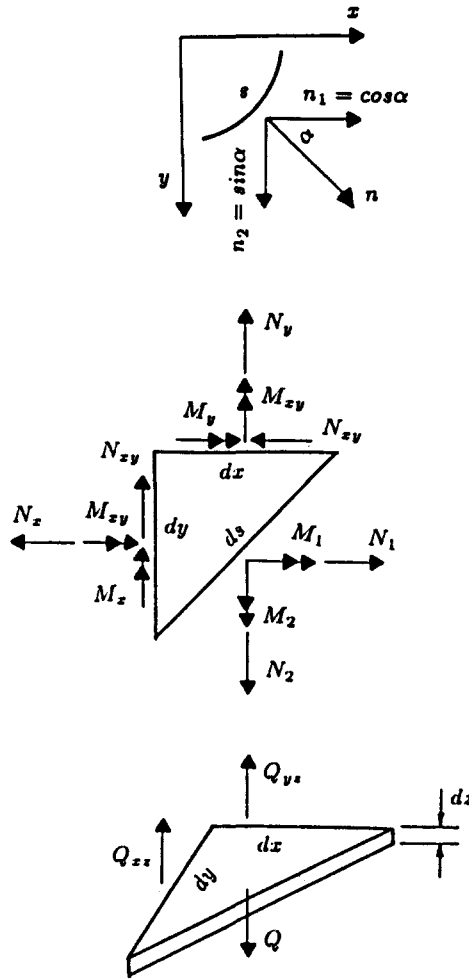

Fig. 3. Equilibrating stress resultants at the boundary.

directions of the principal material axes coincide with the  $x, y$  and  $z$  axes, the terms  $C_{14}$  and  $C_{25}$ , which give rise to coupling between the membrane and bending resultants in (7), will vanish. On the other hand, for a generally orthotropic plate for which the material's principal directions are all inclined to the geometric  $x, y$  and  $z$  directions, the constitutive matrix in (7) will be fully populated, i.e. all components of the generalized strains will be coupled to each other. The "technical orthotropy" being considered here thus really lies in between behaviors exhibited by special and general orthotropies.

By applying equilibrium considerations in the presence of a transverse loading  $P(x, y)$ , the following governing equations for the orthogonally stiffened plate may now be derived :

$$C_{11}u_{,xx} + C_{33}u_{,yy} + (C_{12} + C_{33})v_{,xy} - C_{14}\theta_{,xx} = 0 \tag{8}$$

$$(C_{12} + C_{33})u_{,xy} + C_{33}v_{,xx} + C_{22}v_{,yy} - C_{25}\theta_{,yy} = 0 \tag{9}$$

$$C_{77}w_{,xx} + C_{88}w_{,yy} - C_{77}\theta_{,xx} - C_{88}\theta_{,yy} + P = 0 \tag{10}$$

$$C_{14}u_{,xx} - C_{44}\theta_{,xx} - C_{66}\theta_{,yy} + C_{77}\theta_{,x} - (C_{45} + C_{66})\theta_{,xy} - C_{77}w_{,x} = 0 \tag{11}$$

$$C_{25}v_{,yy} - (C_{45} + C_{66})\theta_{,xy} - C_{66}\theta_{,yx} - C_{55}\theta_{,yy} + C_{88}\theta_{,y} - C_{88}w_{,y} = 0. \tag{12}$$

The above eqns (8)–(12) are subject to the following boundary conditions (see Fig. 3) :

$$u = U(s), \quad \text{or,} \quad N_x n_1 + N_{xy} n_2 = N_1(s) \quad (13)$$

$$v = V(s), \quad \text{or,} \quad N_{xy} n_1 + N_y n_2 = N_2(s) \quad (14)$$

$$w = W(s), \quad \text{or,} \quad Q_{xz} n_1 + Q_{yz} n_2 = Q(s) \quad (15)$$

$$\theta_x = \Theta_x(s), \quad \text{or,} \quad M_x n_1 + M_{xy} n_2 = M_2(s) \quad (16)$$

$$\theta_y = \Theta_y(s), \quad \text{or,} \quad M_{xy} n_1 + M_y n_2 = -M_1(s). \quad (17)$$

Equations (8)–(12) are of 10th-order and are difficult to solve purely analytically, even for relatively simple plate geometry and boundary conditions. A tractable case is that of a simply supported rectangular plate ( $a \times b$ ) where double Fourier (Navier's) type of solutions can be found in the following forms:

$$u = \sum_{m=1}^{\infty} \sum_{n=1}^{\infty} A_{mn} \cos(\alpha_m x) \sin(\beta_n y) \quad (18)$$

$$v = \sum_{m=1}^{\infty} \sum_{n=1}^{\infty} B_{mn} \sin(\alpha_m x) \cos(\beta_n y) \quad (19)$$

$$w = \sum_{m=1}^{\infty} \sum_{n=1}^{\infty} C_{mn} \sin(\alpha_m x) \sin(\beta_n y) \quad (20)$$

$$\theta_x = \sum_{m=1}^{\infty} \sum_{n=1}^{\infty} D_{mn} \cos(\alpha_m x) \sin(\beta_n y) \quad (21)$$

$$\theta_y = \sum_{m=1}^{\infty} \sum_{n=1}^{\infty} E_{mn} \sin(\alpha_m x) \cos(\beta_n y). \quad (22)$$

It is obvious that for the above type of solutions to be applicable it is necessary to express the applied transverse loading as follows:

$$P = \sum_{m=1}^{\infty} \sum_{n=1}^{\infty} P_{mn} \sin(\alpha_m x) \sin(\beta_n y). \quad (23)$$

In (18)–(23) above,

$$\alpha_m = \frac{m\pi}{a} \quad (24.1)$$

$$\beta_n = \frac{n\pi}{b}. \quad (24.2)$$

It is pointed out that the assumed solutions (18)–(22) satisfy the following simply supported type of boundary conditions:

$$\text{at } x = 0, a: \quad v = w = \theta_y = 0 \quad (25.1)$$

$$\text{at } y = 0, b: \quad u = w = \theta_x = 0. \quad (25.2)$$

For a given pair of  $m$  and  $n$ , use of the corresponding terms (and their derivatives) of the series expansions (18)–(23) in eqns (8)–(12) will result in the following matrix equation for the constants  $A_{mn}$ ,  $B_{mn}$ , etc.:

$$\begin{bmatrix}
 (C_{11}x_m^2 + C_{33}\beta_n^2) & (C_{12} + C_{33})x_m\beta_n & 0 & -C_{14}x_m^2 \\
 (C_{12} + C_{33})x_m\beta_n & (C_{33}x_m^2 + C_{22}\beta_n^2) & 0 & 0 \\
 0 & 0 & (C_{77}x_m^2 + C_{88}\beta_n^2) & -C_{77}x_m \\
 -C_{14}x_m^2 & 0 & -C_{77}x_m & (C_{44}x_m^2 + C_{66}\beta_n^2 + C_{77}) \\
 0 & -C_{25}\beta_n^2 & -C_{88}\beta_n & (C_{45} + C_{66})x_m\beta_n \\
 & & 0 & \\
 & & -C_{25}\beta_n^2 & \\
 & & -C_{88}\beta_n & \\
 & & (C_{45} + C_{66})x_m\beta_n & \\
 & & (C_{66}x_m^2 + C_{55}\beta_n^2 + C_{88}) & 
 \end{bmatrix}
 \begin{Bmatrix}
 A_{mn} \\
 B_{mn} \\
 C_{mn} \\
 D_{mn} \\
 E_{mn}
 \end{Bmatrix}
 =
 \begin{Bmatrix}
 0 \\
 0 \\
 P_{mn} \\
 0 \\
 0
 \end{Bmatrix}. \tag{26}$$

For the particular cases of (a) a uniformly distributed load  $p$ , and, (b) a concentrated load  $P_0(a/2, b/2)$ ,  $P_{mn}$  will be given as follows:

$$P_{mn} = \frac{4p}{\pi^2 mn} (\cos m\pi - 1)(\cos n\pi - 1), \quad \text{for case (a)} \tag{27.1}$$

$$= \frac{4P_0}{mn} \sin \frac{m\pi}{2} \sin \frac{n\pi}{2}, \quad \text{for case (b)}. \tag{27.2}$$

The closed form double Fourier solutions furnished in the foregoing serve to check the accuracy of the finite element orthotropic formulation to be discussed in the section that follows.

FINITE ELEMENT FORMULATIONS

Two finite element formulations are relevant to the present exposition: (i) a discrete plate-beam formulation termed FEM(M2) in Deb and Booton (1988), and (ii) a formulation (abbreviated as ORTHO) accounting for technical orthotropy of the type already discussed, and briefly mentioned in Deb and Booton (1988). The formulation FEM(M2) is quite general as compared to ORTHO and hence can be used as a basis for judging the applicability of the latter, constrained mainly by the assumption of closeness of stiffeners. The effectiveness of FEM(M2) has already been shown in Deb and Booton (1988). The orthotropic formulation, which like FEM(M2) employs the isoparametric serendipity, eight-node plate-bending element (Fig. 4), takes into account geometric non-linear behavior, consistent with Von Karman's assumptions for large deflections of plates. The consideration of some of the non-linear terms in the expressions for strains is particularly important for stiffened plates which can support large loads undergoing elastic deformation, greater than the infinitesimal. The salient features of the present non-linear, finite element, orthotropic formulation are listed below:

(a) Finite element approximation:  
displacement field,

$$\delta = \begin{Bmatrix} u \\ v \\ w \\ \theta_x \\ \theta_y \end{Bmatrix} = \sum_{i=1}^n N_i \mathbf{I} \delta_i = \mathbf{N} \delta_n, \tag{28}$$

where  $\delta_i$  is the vector of nodal displacements at the  $i$ th node,  $\mathbf{N}$  is the augmented  $(8 \times 40)$  matrix of shape functions and  $\delta_n$  is the  $(40 \times 1)$  vector of plate nodal displacements.

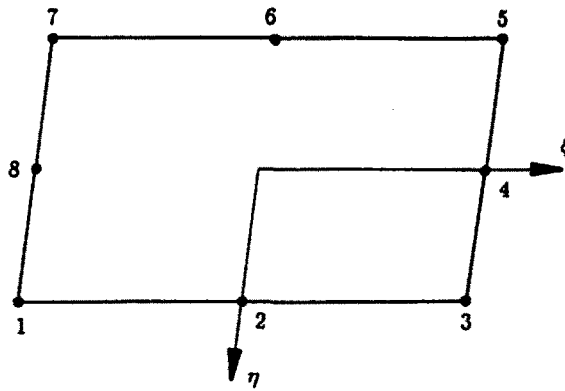

$$N_i = \frac{1}{4}(1 + \xi\xi_i)(1 + \eta\eta_i)(\xi\xi_i + \eta\eta_i - 1)$$

$$i = 1, 3, 5, 7$$

$$= \frac{\xi^2}{2}(1 + \xi\xi_i)(1 - \eta^2) + \frac{\eta^2}{2}(1 + \eta\eta_i)(1 - \xi^2)$$

$$i = 2, 4, 6, 8$$

Fig. 4. The serendipity plate element.

(b) Strain-displacement relations:  
infinitesimal strain field,

$$\bar{\epsilon}_L = \mathbf{L}\bar{\delta} = \mathbf{L}\mathbf{N}\bar{\delta}_n = \mathbf{B}_L\bar{\delta}_n, \tag{29}$$

where  $\bar{\epsilon}_L$  first appears in (7.1),  $\mathbf{L}$  is a matrix of linear differential operators and  $\mathbf{B}_L (= \mathbf{L}\mathbf{N})$  is the linear strain-displacement matrix.

The strain field, in Lagrangian coordinates, by taking into account non-linear displacement gradients consistent with Von Karman's assumptions for large deflection of plates, is given by

$$\bar{\epsilon} = \bar{\epsilon}_L + \bar{\epsilon}_{NL}, \tag{30}$$

where

$$\bar{\epsilon}_{NL} = \left\{ \begin{array}{c} \frac{1}{2}w_x^2 \\ \frac{1}{2}w_y^2 \\ w_{,x}w_{,y} \\ 0 \\ 0 \\ 0 \\ 0 \\ 0 \end{array} \right\}. \tag{31}$$

The strain field due to an incremental (or differential) displacement field is now

$$\dot{\bar{\epsilon}} = \dot{\bar{\epsilon}}_L + \dot{\bar{\epsilon}}_{NL} = (\mathbf{B}_L + \mathbf{A}\mathbf{G})\dot{\bar{\delta}}_n = \mathbf{B}_{NL}\dot{\bar{\delta}}_n, \tag{32}$$

where  $\mathbf{B}_{NL} (= \mathbf{B}_L + \mathbf{A}\mathbf{G})$  is the non-linear strain-displacement matrix, with  $\mathbf{A}$  and  $\mathbf{G}$  given as follows:



$$\mathbf{A}^T = \begin{bmatrix} w_{,x} & 0 & w_{,y} & 0 & 0 & 0 & 0 & 0 \\ 0 & w_{,y} & w_{,x} & 0 & 0 & 0 & 0 & 0 \end{bmatrix} \quad (32.1)$$

$$\mathbf{G} = \begin{bmatrix} 0 & 0 & \frac{\partial}{\partial x} & 0 & 0 \\ 0 & 0 & \frac{\partial}{\partial y} & 0 & 0 \end{bmatrix} \mathbf{N}. \quad (32.2)$$

(c) Invoking virtual work principle and using a total Lagrangian approach, it is possible to write

$$\int_A \bar{\boldsymbol{\varepsilon}}^T \bar{\boldsymbol{\sigma}}' dA = \bar{\boldsymbol{\delta}}_n^T \bar{\mathbf{R}}, \quad (33)$$

where  $A$  is the undeformed plate mid-surface,  $\bar{\boldsymbol{\sigma}}'$  is the second Piola–Kirchhoff stress vector and  $\bar{\mathbf{R}}$  is the vector of plate nodal forces. As a first approximation, we assume that displacement gradients are small compared to unity and rigid body rotations can be ignored. The second Piola–Kirchhoff stresses  $\bar{\boldsymbol{\sigma}}'$  in (33) can then be replaced by the Cauchy stresses  $\bar{\boldsymbol{\sigma}}$ . Also, employing (32) and the condition of arbitrariness of the virtual displacement field  $\bar{\boldsymbol{\delta}}_n$ , (33) can be reduced to

$$\int_A \mathbf{B}_{NL}^T \bar{\boldsymbol{\sigma}} dA - \bar{\mathbf{R}} = 0. \quad (34)$$

In the above equation, the integrand is a non-linear function of the nodal displacement vector  $\bar{\boldsymbol{\delta}}_n$ . An iterative solution to this equation can be sought by using the tangent stiffness (Newton–Raphson) method. The solution scheme for the present case is much the same as described by Pica *et al.* (1980).

#### RANGE OF VALIDITY STUDY OF THE ORTHOTROPIC THEORY

In order to assess the range of validity of the orthotropic formulation ORTHO, the various parameters likely to affect the assumptions of technical orthotropy are, at first, identified using the principles of dimensional analysis and a comparison is then carried out in the linear range with the more general formulation FEM(M2). For convenience the simplified problem of a square plate ( $a = b = l$ ), orthogonally stiffened with an equal number of rectangular stiffeners in the  $x$  and  $y$  directions, possessing identical sectional and material properties is considered. In order to estimate the deviation of maximum deflection and plate, as well as stiffener stresses obtained through ORTHO with respect to those obtained through FEM(M2), the following parameters are introduced:

$$\eta_w = \frac{\text{Maximum deflection obtained using ORTHO}}{\text{Maximum deflection obtained using FEM(M2)}} \quad (35)$$

$$\eta_{sp} = \frac{\text{Maximum plate stress obtained using ORTHO}}{\text{Maximum plate stress obtained using FEM(M2)}} \quad (36)$$

$$\eta_{st} = \frac{\text{Maximum stiffener stress obtained using ORTHO}}{\text{Maximum stiffener stress obtained using FEM(M2)}} \quad (37)$$

Let the parameters  $\eta_w$ ,  $\eta_{sp}$  and  $\eta_{st}$ , which are all dimensionless, be together denoted as  $\eta$ . The dependence of  $\eta$  on the relevant parameters may be expressed symbolically as follows:

$$\eta = \phi(l, t, b_s, d_s, s, E, E_s, \mu, LT, BC), \quad (38)$$

where

$\phi$  = "function of"

$l, t$  = plate span, thickness respectively

$b_s, d_s$  = stiffener-web width, depth, respectively

$s$  = spacing of stiffeners

$E, \mu$  = Young's modulus, Poisson's ratio, respectively, for the plate material

$E_s$  = Young's modulus for the stiffener material

$LT \equiv$  Loading type, concentrated or uniformly distributed

$BC \equiv$  Simply supported or fully clamped boundary conditions.

In eqn (38),  $LT$  and  $BC$  are discrete conditions for which no numerical values are necessary and it suffices to remember that these parameters should be varied. A dimensional analysis (Deb *et al.*, 1985; Deb and Deb, 1986) of the remaining variables in (38) will result in the following possible set of seven dimensionless  $\pi$ -parameters:

$$\pi_1 = l/t, \quad \pi_2 = l/b_s, \quad \pi_3 = d_s/t, \quad \pi_4 = s/l, \quad \pi_5 = E/E_s, \quad \pi_6 = \mu, \quad \pi_7 = \eta. \quad (39)$$

In the above set of  $\pi$ -parameters,  $\pi_1$  identifies whether the plate is thin or thick;  $\pi_2$  may be utilized to study the effect of the span size of a plate for a given web width of stiffeners;  $\pi_3$  is a measure of eccentricity of stiffeners;  $\pi_4$  is a significant parameter which is used to study the degree of proximity of stiffeners beyond which the orthotropic formulation would be, by and large, unacceptable; the parameter  $\pi_5$  is modified to a more meaningful rigidity ratio  $D/D_s$ , as shown later; the parameter  $\pi_6$  is not likely to play any role in affecting smeared behavior and hence has been kept constant at 0.3; and,  $\pi_7$  is basically the set of dependent variables  $\eta_w, \eta_{sp}$  and  $\eta_{so}$ , whose numerical differences with unity will indicate the extent of approximation introduced by the smearing of stiffeners in the orthotropic theory.

It is known from plate theory that  $E/(1-\mu^2)$  is a more meaningful quantity for plates rather than simply  $E$  because of its two-dimensional behavior. Using this fact and the technique of compounding (Deb *et al.*, 1985) in dimensional analysis,  $\pi_5$  is transformed as follows:

$$\begin{aligned} \pi_5 &\rightarrow \left( \frac{E}{1-\mu^2} \frac{1}{E_s} \right) \frac{1}{\pi_3^3} \pi_4 \pi_2 = \frac{E}{1-\mu^2} \frac{1}{E_s} \frac{t^3}{d_s^3} \frac{s}{l} \frac{l}{b_s} \\ &= \frac{Et^3}{12(1-\mu^2)} \frac{12s}{E_s b_s d_s^3} = \frac{D}{D_s} \end{aligned} \quad (39.1)$$

where  $D$  and  $D_s$  are, respectively, the plate and stiffener rigidities:

$$D = \frac{Et^3}{12(1-\mu^2)} \quad (39.2)$$

$$D_s = \frac{E_s b_s d_s^3}{12s} \quad (39.3)$$

In the present parametric study, the stiffened plate system is assumed to be made up of one material, i.e.  $E = E_s$ , resulting in a further modification of the parameter  $D/D_s$ . Rewriting  $D/D_s$ , under the preceding assumption ( $E = E_s$ ), we have

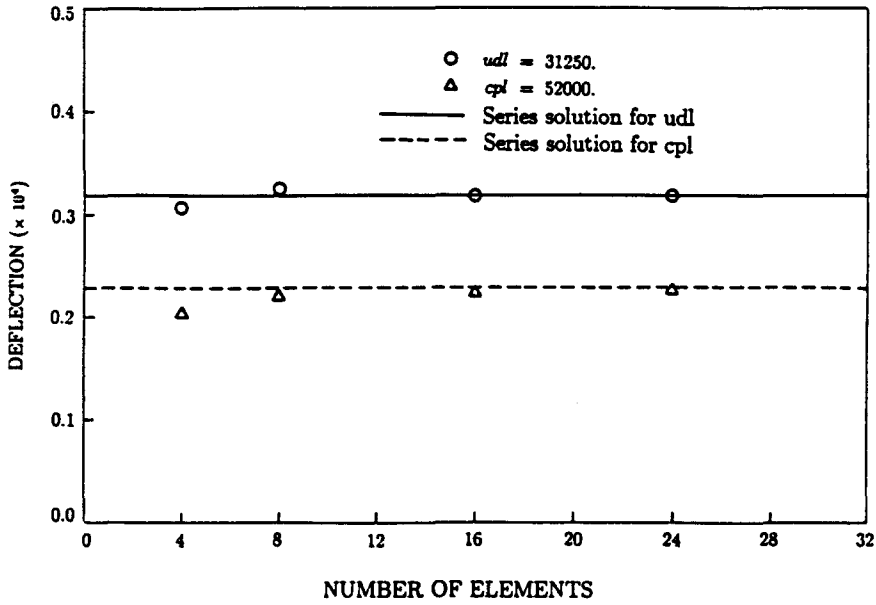

Fig. 5. Convergence study.

$$\frac{D}{D_s} = \frac{1}{1-\mu^2} \frac{l}{b_s} \left(\frac{t}{d_s}\right)^3 \frac{s}{l} = \frac{1}{1-\pi_6^2} \pi_2 \frac{1}{\pi_3} \pi_4. \tag{39.4}$$

Since  $\pi_6 (= 0.3)$  is kept constant, it is evident from (39.4) above that  $\pi_2$  will be determined if  $\pi_5 (= D/D_s)$ ,  $\pi_3$  and  $\pi_4$  are known. Hence, for the purpose of demarcating the range of validity of ORTHO, it is only necessary to study the influence of the following parameters on  $\eta$ :

$$\pi_1 = l/t, \quad \pi_3 = d_s/t, \quad \pi_4 = s/l, \quad \pi_5 = D/D_s, LT, BC. \tag{40}$$

Before starting the intended parametric study, the convergence characteristic of ORTHO needs to be checked. For this purpose, a comparison is made with the series solutions presented in an earlier section [eqns (18)–(27.2)] by taking a simply supported rectangular stiffened plate with 14 stiffeners in the  $x$  direction (i.e.  $n_{xx} = 14$ ,  $n_{yy} = 0$ ), with the following geometrical and material properties:

for the plate:

$$a = 4, \quad b = 2, \quad t = 0.1$$

$$E = 2 \times 10^{11}, \quad \mu = 0.3$$

for the stiffeners:

$$d_x = 0.5, \quad b_{wx} = 0.1$$

$$E_{wx} = 2 \times 10^{11}.$$

The results of convergence study (for central deflection  $w$ ) are shown in Fig. 5 for two cases: (a) udl (uniformly distributed load) = 31,250, and, (b) cpl (central point load) = 52,000. Excellent convergence (up to three decimal places) is obtained for about 16 elements for case (a) and for about 24 elements for case (b). To obtain similar convergence for stresses for the present displacement-based method however, a slightly higher number of elements is necessary.

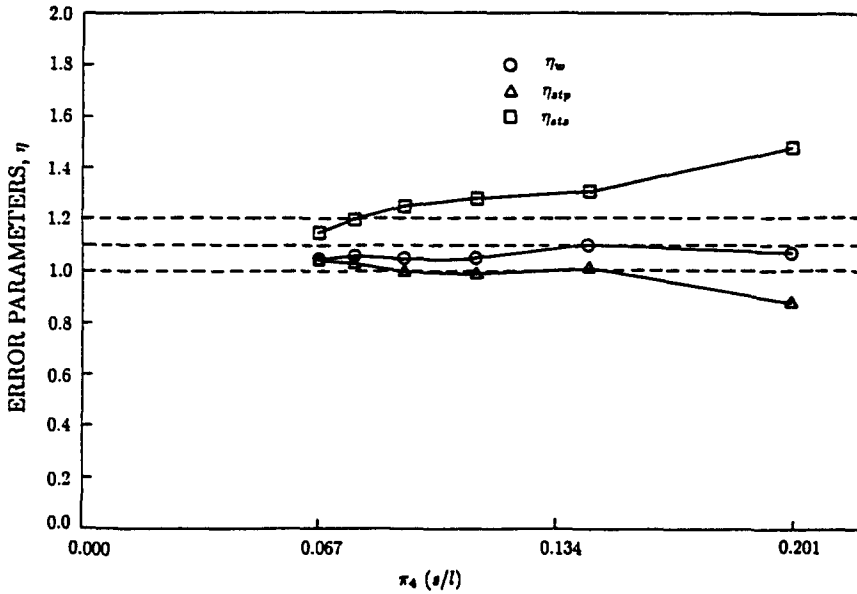

Fig. 6. Case Study I ( $\pi_1 = 100$ ,  $\pi_3 = 5$ ,  $LT \equiv udl$ ,  $BC \equiv C-C-C-C$ ).

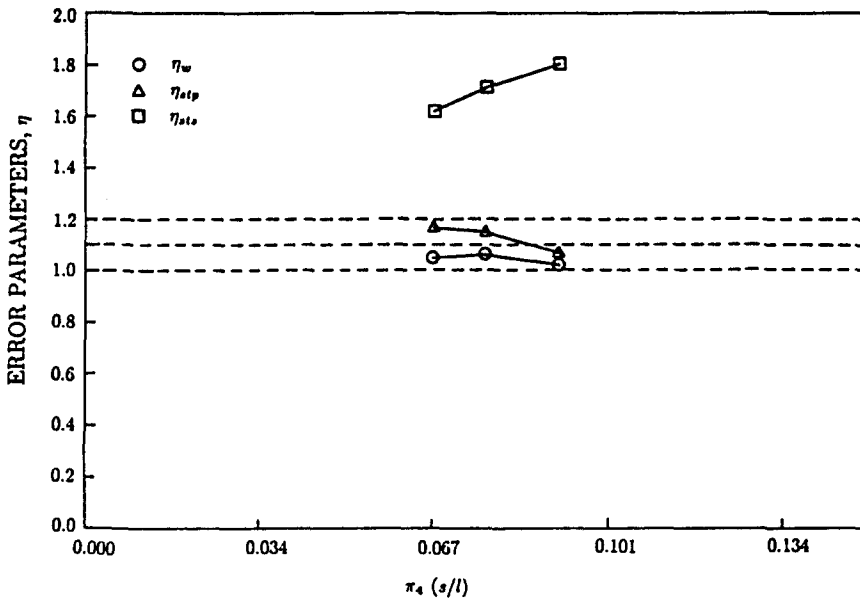

Fig. 7. Case Study II ( $\pi_1 = 100$ ,  $\pi_3 = 5$ ,  $LT \equiv cpl$ ,  $BC \equiv C-C-C-C$ ).

In order to investigate the effects of the parameters in (40) on the applicability of ORTHO, a series of five case studies was carried out for which the results are shown in Figs 6–10. These case studies are described below.

In Case Study I (Fig. 6), the effect of variation of  $\pi_4$  ( $= s/l$ ) on the accuracy parameter  $\eta$  is shown. [The dotted lines in Fig. 6 pertain to 0%, 10% and 20% deviation of ORTHO from FEM(M2) for  $\eta = 1$ , 1.1 and 1.2 respectively.] For this case study, the following parameters are kept constant:

$$\pi_1 = 100, \quad \pi_3 = 5, \quad Lt \equiv udl, \quad BC \equiv \text{all-sides-clamped (C-C-C-C)}. \quad (41)$$

It can be observed from Fig. 6 that for  $\pi_4 = 0.067$  (i.e. 14 stiffeners in either direction),

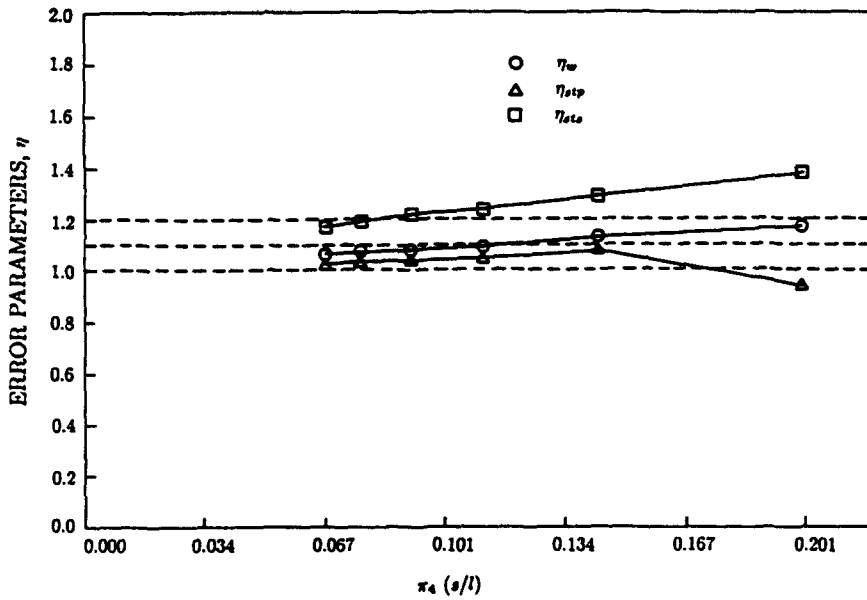

Fig. 8. Case Study III ( $\pi_1 = 100, \pi_3 = 5, LT \equiv udl, BC \equiv S-S-S-S$ ).

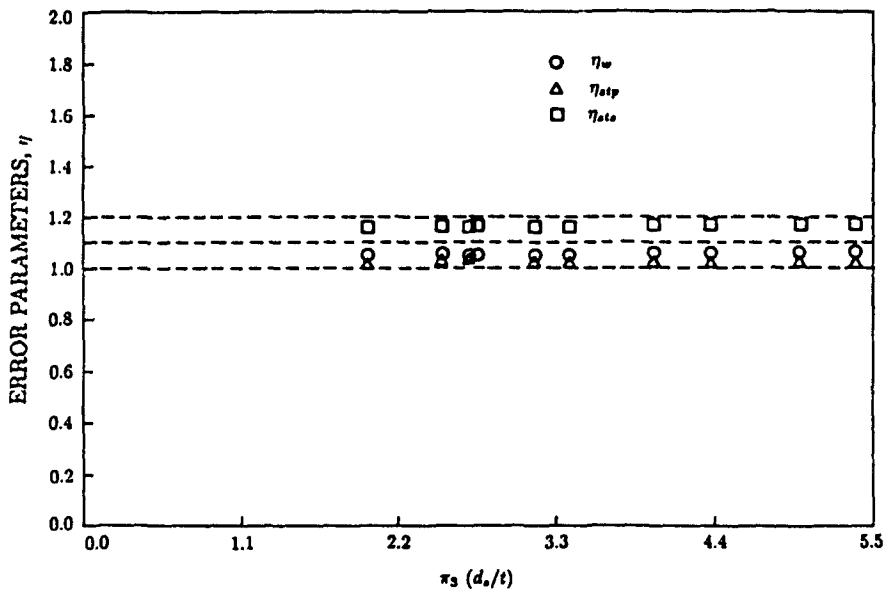

Fig. 9. Case Study IV ( $\pi_1 = 100, \pi_4 = 0.067, LT \equiv udl, BC \equiv S-S-S-S$ ).

deflection and plate stresses are well within 10% and stiffener stresses well within 20% on the safer side. As  $\pi_4$  increases, i.e. the stiffeners become increasingly sparse, the formulation ORTHO tends to deviate significantly from FEM(M2). The spirit of Case Study I is retained in Case Study II with the exception of the parameter  $LT$ , which has been changed to the concentrated type. Thus, in Case Study II (Fig. 7), variation of  $\eta$  with respect to  $\pi_4$  is presented for a central point load (cpl). It appears that even for a low value such as  $\pi_4 = 0.067$ , ORTHO significantly overestimates the stiffener stresses. It may therefore not be instructive to use the orthotropic formulation for concentrated loadings unless the stiffeners are inordinately closely spaced. Case Study III (Fig. 8) differs from Case Study I with respect to the boundary conditions, i.e. the parameter  $BC$  is now changed to an all-sides-simply-supported ( $S-S-S-S$ ) condition. On account of the close similarity of variation

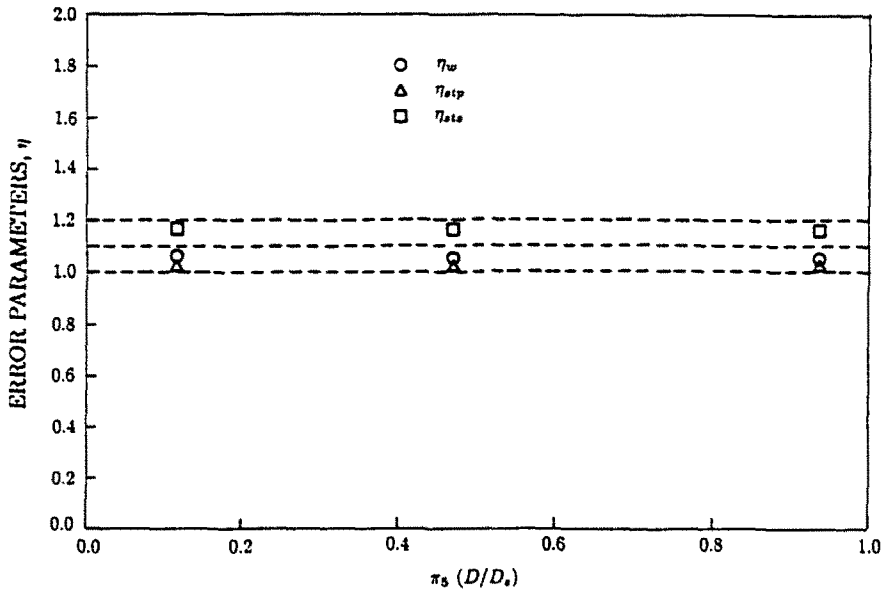

Fig. 10. Case Study V ( $\pi_1 = 100$ ,  $\pi_4 = 0.067$ ,  $LT \equiv udl$ ,  $BC \equiv S-S-S-S$ ).

in  $\eta$  values for Case Studies I and III, it appears reasonable to conclude that support conditions have negligible effect on the assumption of technical orthotropy. On the basis of the observations made for Case Studies I-III, it may be tentatively accepted that the deflection and plate stresses are estimated reasonably accurately (well within 10% on the safer side) for engineering purposes, and stiffener stresses well within 20% by the orthotropic formulation for  $\pi_4 = 0.067$  and uniformly distributed loading. The effects of the eccentricity parameter  $\pi_1$  ( $= d_s/t$ ) and the rigidity ratio  $\pi_5$  ( $= D/D_s$ ) are investigated in Case Studies IV and V (Figs 9 and 10) for  $\pi_4 = 0.067$  and  $LT \equiv udl$ . The constancy of  $\eta$  for the last mentioned cases for different values of  $\pi_1$  and  $\pi_5$  seem to indicate that these parameters do not affect the assumptions of technical orthotropy. It may be noted that the plate aspect ratio  $\pi_1$  has been kept constant at 100 for all the case studies discussed herewith. However, it was found that the parameter  $\pi_1$ , like  $\pi_3$  and  $\pi_5$ , did not give rise to any recognizable variation in  $\eta$  for a given value of non-dimensional stiffener spacing  $\pi_4$ .

Observations made above with regard to Case Studies I-V seem to corroborate and additionally quantify the prevalent qualitative opinions on the orthotropic theory. It was stated by Huffington (1956) that the orthotropic theory is applicable provided the ratio of stiffener spacings to plate boundary dimensions are small enough. Hoppmann *et al.* (1956) compared their theoretical and experimental results on deflections and strains which they found in close agreement, considering an 11 in.  $\times$  11 in.-plate stiffened in one direction with 15 stiffeners. The theoretical calculations were based on an orthotropic theory. In the present investigation, deflections and plate stresses have been found to be within 5-10% for  $s/l = 0.067$ , i.e. for 14 stiffeners in any direction. This is an interesting correlation with the number of stiffeners, viz. 15 chosen by Hoppmann and Huffington (1956) probably on the basis of experimental observations. The inaccuracy of the orthotropic theory for the case of concentrated loadings was observed by Clarkson (1962). Case Study II specifically indicates the large overestimation of stiffener stresses that may result from the application of the orthotropic theory to stiffened plates with concentrated loads. It was "tacitly assumed" by Hoppmann and Huffington (1956) that their orthotropic analysis was not affected by the plate boundary conditions; in the present numerical study, no significant changes in the values of  $\eta$  were found for C-C-C-C and S-S-S-S conditions. It was remarked by Troitsky (1971) that rigorous analysis procedures yield somewhat lower values of stresses as compared to those obtained using Huber's orthotropic theory. The trends in Case Studies I-V confirm this statement as in most cases the  $\eta$  parameters are greater than unity.

## RESULTS OF THE NON-LINEAR ANALYSIS AND DISCUSSION

A geometrically non-linear and materially elastic analysis for eccentrically stiffened plates, under orthotropic assumptions using an integral equation method, was presented by Srinivasan and Ramchandran (1977). A quantity  $r_{pt}$  was defined by the pre-mentioned authors as a characteristic for stiffened plates as follows:

$$r_{pt} = \frac{\text{Volume of deck plate per unit area}}{\text{Total volume of plate and stiffeners per unit area}} \quad (42)$$

In light of the observations already made, the quantity  $r_{pt}$  needs closer examination. Employing the notation of eqn (38) and following the definition of  $r_{pt}$  in (42), we have

$$r_{pt} = \frac{l^2 t}{l^2 t + 2nb_s d_s l} = \frac{\frac{l}{b_s}}{\frac{l}{b_s} + 2\left(\frac{l}{s} - 1\right) \frac{d_s}{t}} \quad (43)$$

where  $n$  = number of stiffeners in any direction

$$= \frac{l}{s} - 1. \quad (43.1)$$

It is seen from (43) that  $r_{pt}$  is a function of three non-dimensional quantities  $l/b_s$ ,  $s/l$  and  $d_s/t$  which are all included in the list of  $\pi$ -parameters in (39). If  $r_{pt}$  together with  $s/l$  and  $d_s/t$  are used as representative parameters, the quantity  $l/b_s$  is automatically fixed (so  $r_{pt}$  may be viewed as a parameter in lieu of  $l/b_s$ ). Furthermore, if  $s/l$ ,  $d_s/t$  and  $l/b_s$  are known,  $D/D_s$  is also known in view of relation (39.4) for plates and stiffeners made of the same material. Hence, it is sufficient to plot, in the thin plate range, representative values of deflection and plate, as well as stiffener stresses against  $r_{pt}$ ,  $s/l$  and  $d_s/t$  given the loading and boundary conditions. In order to attempt a comparison with Srinivasan and Ramchandran (1977), clamped plates under uniformly distributed loading are considered. In accordance with the conventions followed by the previous authors, the representative deflection and plate, as well as stiffener stresses are normalized as follows:

normalized deflection,

$$\bar{w} = \frac{w_m}{h} \quad (44.1)$$

normalized plate stress,

$$S_T = \sigma_{pm} \frac{(1 - \mu^2) l^2}{E h^2} \quad (44.2)$$

normalized stiffener stress,

$$S_E = \sigma_{sm} \frac{(1 - \mu^2) l^2}{E h^2}, \quad (44.3)$$

where  $w_m$ ,  $\sigma_{pm}$  and  $\sigma_{sm}$  are respectively the deflection, plate-top stress and stiffener-bottom stress at the plate centre, and,

$$\begin{aligned} \bar{h} &= \frac{\text{Total volume of plate and stiffeners}}{\text{Area of the stiffened plate}} \\ &= \frac{l^2 t + 2nb_s d_s l}{l^2} = t + 2\left(\frac{l}{s} - 1\right) \frac{b_s d_s}{l}. \end{aligned} \quad (44.4)$$

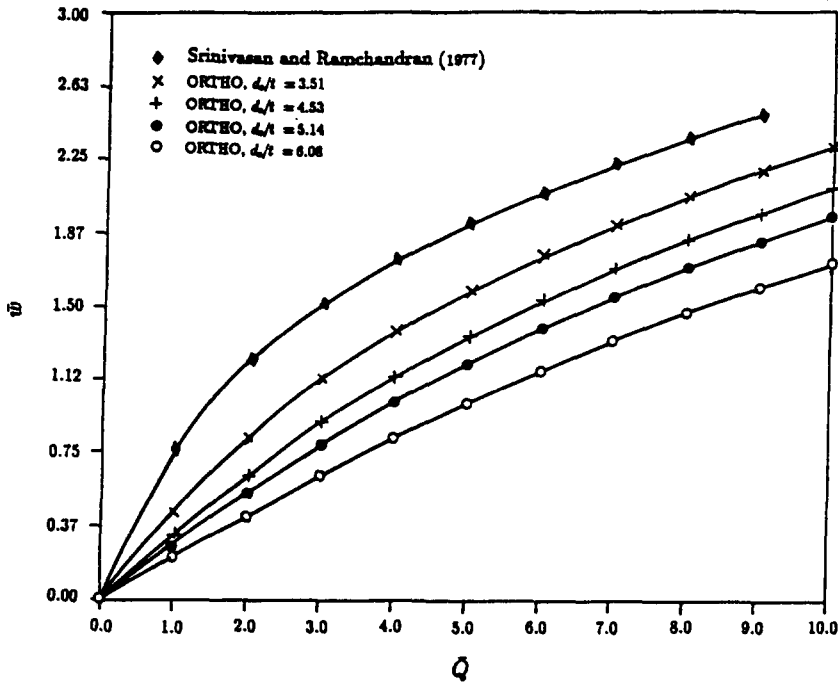

Fig. 11. Load vs deflection ( $r_{pt} = 0.9$ ,  $\pi_4 = 0.067$ ).

A normalized loading parameter  $\bar{Q}$  is also defined following Srinivasan and Ramchandran (1977):

$$\bar{Q} = \frac{ql^4}{\bar{D}h}, \quad (45)$$

where  $q$  is the intensity of uniformly distributed loading, and

$$\bar{D} = \frac{Eh^3}{12(1-\mu^2)}. \quad (45.1)$$

All quantities not defined in relations (43)–(45.1) above have been defined in the preceding section on the range of validity study of ORTHO.

It may be noted that a value of  $r_{pt}$  equal to unity represents an unstiffened plate. For such a plate, very good agreement was obtained with the results of Srinivasan and Ramchandran (1977) for normalized deflection and stresses given by (44.1)–(44.3), with respect to the non-dimensional load  $\bar{Q}$ . For stiffened plates, results are presented for various values of  $d_s/t$  in Figs 11–13 for  $r_{pt} = 0.9$ , whilst maintaining  $s/l$  constant at 0.067 (by treating this value as a cut-off point for applicability of the orthotropic theory). In their results for the orthogonally stiffened plate, the previous authors have characterized a stiffened plate system on the basis of the single parameter  $r_{pt}$ . However, as apparent in Figs 11–13, the eccentricity parameter  $d_s/t$  has a significant effect on the outcome of results for a given value of  $r_{pt}$ . Consequently, the results of the above-referenced authors seem to suffer from a lack of uniqueness. It is observed from Fig. 11 that with increasing values of  $d_s/t$ ,  $\bar{w}$  decreases, which is an expected outcome (orthotropic bending rigidity is a cubic function of  $d_s$  for given plate thickness and material properties). At lower load levels, the stresses do not seem to vary much with  $d_s/t$ ; however, at higher loads, the differences in stresses are quite remarkable for different values of  $d_s/t$  with stresses showing an increase with increasing values of  $d_s/t$ .



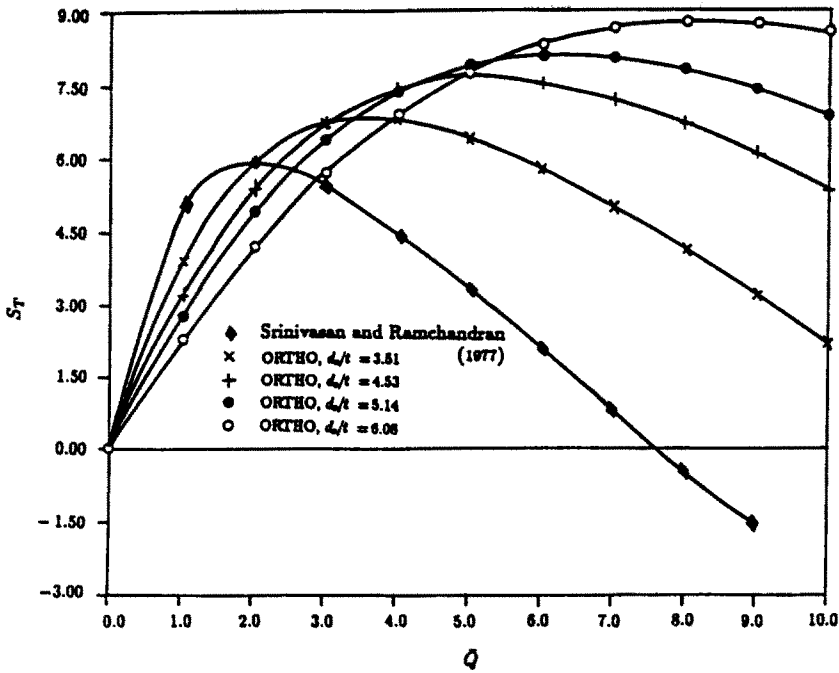

Fig. 12. Load vs top-stress ( $r_{pl} = 0.9, \pi_4 = 0.067$ ).

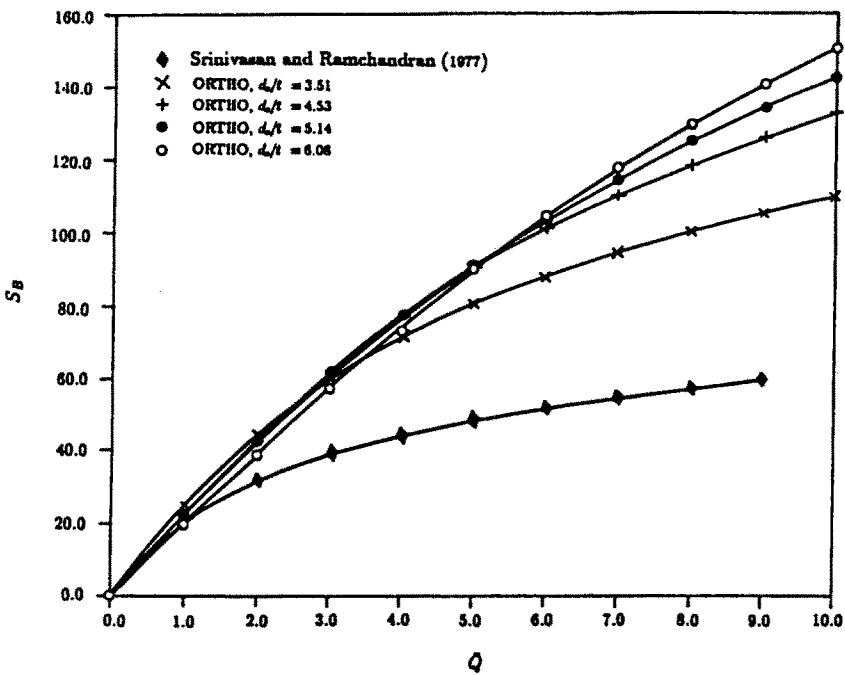

Fig. 13. Load vs bottom-stress ( $r_{pl} = 0.9, \pi_4 = 0.067$ ).

CONCLUSIONS

A shear-deformable orthotropic theory has been presented for plates with closely-spaced, eccentric open-web stiffeners having negligible torsional stiffness. The finite element formulation presented also models geometric non-linear behavior. The question of how close the stiffeners should be for the orthotropic approach to yield reasonable results has been investigated in the thin plate range. It appears that at least 14 stiffeners are necessary

(for  $s/l = 0.067$ ) along any direction in the presence of distributed loading, to obtain deflection and plate stresses well within 10% on the safer side from an orthotropic approach. It has also been shown that along with a volumetric ratio parameter as used by earlier authors, an eccentricity parameter should also be taken into account in presenting results for a stiffened plate system.

*Acknowledgement*—The authors gratefully acknowledge financial support by a Natural Sciences and Engineering Research Council of Canada operating grant A-0265, for the work described in the present paper.

#### REFERENCES

- Bares, R. and Massonnet, C. (1966). *Analysis of Beam Grids and Orthotropic Plates*. Frederick Ungar, NY.
- Clarkson, J. (1962). The behaviour of deck stiffening under concentrated loads. *Trans. R. Inst. Naval Arch.* **104**, 57–65.
- Deb, A. and Booton, M. (1988). Finite element models for stiffened plates under transverse loading. *Comput. Struct.* **28**(3), 361–372.
- Deb, M. K. and Deb, A. (1986). The matrix method: a powerful technique in dimensional analysis. *J. Franklin Inst.* **321**(4), 233–240.
- Deb, A., Deb, M. K. and Sharp, J. J. (1985). A comparative study of the techniques in dimensional analysis. *Appl. Math. Notes* **10**(4), 17–34.
- Hoppmann (II), W. H., Huffington Jr, N. J. and Magness, L. S. (1956). A study of orthogonally stiffened plates. *J. Appl. Mech. Trans. ASME* **23**(3), 343–350.
- Huffington Jr, N. J. (1956). Theoretical determination of rigidity properties of orthogonally stiffened plates. *J. Appl. Mech. Trans. ASME* **23**(1), 15–20.
- Mukhopadhyay, M. and Satsangi, S. K. (1984). Isoparametric stiffened plate bending element for the analysis of ships' structures. *Trans. R. Inst. Naval Arch.* **126**, 141–151.
- Pica, A., Wood, R. D. and Hinton, E. (1980). Finite element analysis of geometrically non-linear plate behaviour using a Mindlin formulation. *Comput. Struct.* **11**, 203–215.
- Srinivasan, R. S. and Ramchandran, S. B. (1977). Linear and non-linear analysis of stiffened plates. *Int. J. Solids Structures* **13**, 897–912.
- Troitsky, M. S. (1971). *Stiffened Plates*. Elsevier, Amsterdam.

#### APPENDIX

The stiffness coefficients in (7) are given as follows :

$$C_{11} = \frac{E_p t}{1 - \mu^2} + r_x E_x d_x$$

$$C_{12} = \frac{\mu E_p t}{1 - \mu^2}$$

$$C_{14} = \frac{1}{2} r_x E_x d_x (t + d_x)$$

$$C_{22} = \frac{E_p t}{1 - \mu^2} + r_y E_y d_y$$

$$C_{25} = \frac{1}{2} r_y E_y d_y (t + d_y)$$

$$C_{33} = C_p t$$

$$C_{44} = \frac{E_p t^3}{12(1 - \mu^2)} + \frac{1}{2} r_x E_x d_x (d_x^2 + \frac{1}{2} d_x t + \frac{1}{4} t^2)$$

$$C_{45} = \frac{\mu E_p t^3}{12(1 - \mu^2)}$$

$$C_{55} = \frac{E_p t^3}{12(1 - \mu^2)} + \frac{1}{2} r_y E_y d_y (d_y^2 + \frac{1}{2} d_y t + \frac{1}{4} t^2)$$

$$C_{66} = \frac{E_p t^3}{24(1 + \mu)}$$

$$C_{77} = \frac{2}{3} G_p t + \frac{1}{3} r_x G_x d_x$$

$$C_{88} = \frac{2}{3} G_p t + \frac{1}{3} r_y G_y d_y$$

where

$$r_x = \frac{n_x h_{xx}}{b}$$

$$r_y = \frac{n_y h_{yy}}{a}$$

$n_x$  = total number of x-stiffeners

$n_y$  = total number of y-stiffeners.